

**4831
POLO**



**4497
PAUL**



**4499
GABIN**



**4500
SUZON**



Attention. Warning. Achtung. Advertencia. Avvertenza. Atenção. Waarschuwing. Ostrzeżenie. Figyelmeztetés. Upozornenie. Upozornění. Upozorenje. Προειδοποίηση. Opozorilo. Внимание. Avertisment.

- FR -Informations à conserver.
- EN -Please keep this information.
- DE -Die Informationen bitte aufbewahren.
- ES -Conservar estas informaciones.
- IT -Informazioni da conservare.
- PT -Conservar estas informações.
- NL -Gelieve deze informatie te bewaren.
- PL -Informacje, które należy zachować.
- HU -Megőrzendő információ.
- SK -Informácie o výrobku – starostlivo uschovajte.
- CZ -Tyto informace si prosím uchovejte.
- HR -Sačuvajte ove informacije.
- EL -Πληροφορίες που πρέπει να διατηρούνται.
- SL -Informacije, ki jih je treba hraniti.
- BG -Информация, която следва да се съхранява.
- RO -Informații care trebuie păstrate.

- FR -Pour enfants de 3 à 12 ans (50 kg max). (Sauf siège bébé : 6-24 mois / 15 kg max)
- EN -For children from 3 to 12 years (50 kg max). (Except baby seat : 6-24 months / 15 kg max.)
- DE -Für Kinder zwischen 3 und 12 Jahren vorgesehen (50 kg max). (außer dem Babysitz : 6-24 Monaten / 15 Kg max)
- ES -Productos destinados a niños entre 3 y 12 años (50 kg max). (Excepto sede bebé : 6-24 meses / 15 Kg max)
- IT -Prodotti destinati a bambini di età compresa tra 3 e 12 anni (50 kg max). (Salvo sede bambino : 6-24 mesi / 15 Kg max)
- PT -Para crianças com idade compreendida entre o 3 e os 12 anos (50 kg max). (Excepto sede bebé : 6-24 meses / 15 Kg max)
- NL -Producten bestemd voor kinderen van 3 tot 12 jaar (50 kg max). (Behalve baby zitje : 6-24 maanden / 15 Kg max)
- PL -Produkt dla dzieci w wieku od 3 do 12 lat (maksymalnie 50 kg). (Oprócz siedziska dla małych dzieci od 6 do 24 miesięcy / maks. 15 kg)
- HU -3-12 éves gyermekek számára (max. 50kg). (Kivéve babaülés : 6-24 hónapos korig / max. 15 kg)
- SK -Pre deti vo veku 3 až 12 rokov (max. 50 kg). (Okrem sedadla pre batolata : 6-24 mesiacov / max. 15 kg)
- CZ -Pro děti od 3 do 12 let (max. 50 kg). (Kromě dětské sedačky : 6-24 měsíců / max. 15 kg)
- HR -Za djecu od 3 do 12 godina (najviše 50 kg). (Izuzev dječje sjedalice : 6 – 24 meseca / najviše 15 kg)
- EL -Για παιδιά 3 ως 12 ετών (μέγιστο βάρος 50 kg). (Εκτός παιδικού καθίσματος : 6-24 μηνών / max. 15 kg).
- SL -Za otroke od 3 do 12 let (največ 50 kg). (Razen otroškega sedeža : 6-24 mesecev/največ 15 kg)
- BG -За деца от 3 до 12 години (50 кг макс.). (С изключение на бебешка седалка : 6-24 месеца / 15 кг макс.)
- RO -Pentru copii de la 3 până la 12 ani (max. 50 kg). (Cu excepția scaunului pentru bebeluș : 6-24 luni / max. 15 kg)



- FR -Réservé à un usage familial en extérieur.
- EN -Only for outdoor domestic use.
- DE -Nur für den Hausgebrauch. Nur für Verwendung im Freien.
- ES -Sólo para uso doméstico. Solo para uso exterior.
- IT -Solo per uso domestico. Solo per uso esterno.
- PT -Apenas para uso doméstico para exterior.
- NL -Uitsluitend voor huishoudelijk gebruik en voor buitengebruik.
- PL -Wyłącznie do użytku domowego. Wyłącznie do użytku na wolnym powietrzu.
- HU -Csak otthoni használatra. Csak kültéri használatra.
- SK -Iba na domáce použitie. Len na používanie vonku.
- CZ -Jen pro domácí použití. Jen pro venkovní použití.
- HR -Samo za uporabu u domu. Samo za uporabu na otvorenom prostoru.
- EL -Μόνο για οικιακή χρήση. Μόνο για χρήση εξωτερικό χώρο.
- SL -Samo za domačo uporabo. Samo za uporabo na prostem.
- BG -За употреба само в домашни условия. Само за употреба на открито.
- RO -Numai pentru uz casnic in exterior.



FOREST-STYLE
236, avenue Clément Ader
59118 Wambrechies
FRANCE
www.soulet.com



Soulet

FUN SINCE 1846

FR -SÉLECTIONNEZ VOTRE MODÈLE
EN -SELECT YOUR MODEL
DE -WÄHLEN SIE IHR MODELL
ES -SELECCIONE SU MODELO
IT -SELEZIONA IL TUO MODELLO
PT -SELECCIONA O SEU MODELO

NL -SELECTEER UW MODEL
PL -WYBIERZ SWÓJ MODEL
HU -VÁLASZSA KI A MODELLT
SK -VYBERTE SI SVOJ MODEL
CZ -VYBERTE SI SVŮJ MODEL
HR -ODABERITE SVOJ MODEL

EL -ΕΠΙΛΕΞΤΕ ΤΟ ΜΟΝΤΕΛΟ ΣΑΣ
SL -IZBERITE SVOJ MODEL
BG -ИЗБЕРЕТЕ ВАШИЯ МОДЕЛ
RO -SELECTAȚI MODELUL
DUMNEAVOASTRĂ

A 4831 POLO

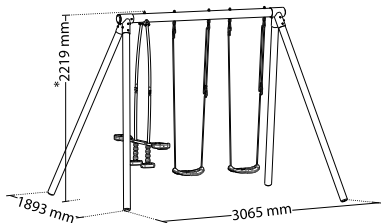

B 4497 PAUL

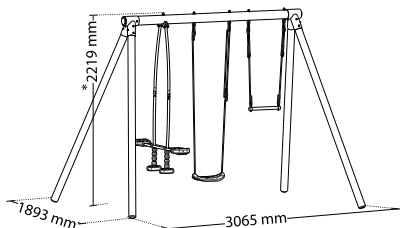

C 4499 GABIN

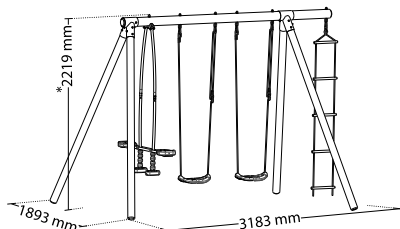

D 4500 SUZON

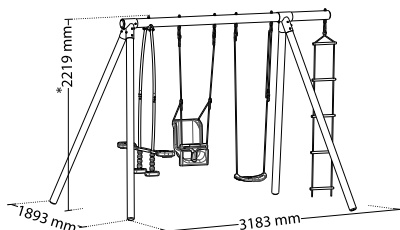





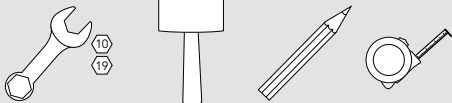



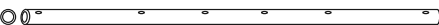









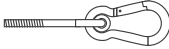

- * FR -les cotes ci-dessus sont indicatives, elles peuvent varier selon la méthode de montage.
EN -Above dimensions are indicative, they can varied according to the assembly method.
DE -Die oben angegebenen Maßangaben sind unverbindlich. Sie können je nach Aufbauverfahren abweichen.
ES -Las dimensiones más arriba son indicativas, pueden variar según el método de montaje.
IT -Le dimensioni sono indicative, possono variare secondo il metodo di montaggio.
PT -As dimensões acima são indicativas, podem variar de acordo com o método de montagem.
NL -De hierboven opgegeven afmetingen zijn indicatief, zij kunnen afwijken naargelang de manier van montage.
PL -Powyższe wartości są orientacyjne, mogą się różnić w zależności od metody montażu
HU -A fenti értékelések indikatívak, a szerelési módtól függoen változhatnak
SK -Výššie uvedené rozmery sú orientačné, môžu sa meniť podľa spôsobu montáže.
CZ -Výše uvedené rozměry jsou pouze orientační, mohou se lišit podle způsobu montáže.
HR -Gore navedene dimenzije su indikativne, mogu se razlikovati ovisno o načinu montaže.
EL -Οι παρακάτω διαστάσεις είναι ενδεικτικές, μπορεί να διαφέρουν αναλόγως της μεθόδου εγκατάστασης.
SL -Zgoranje mere so okvirne, lahko se razlikujejo glede na način pritrditve.
BG -Горните размери са ориентировъчни, те могат да варират в зависимост от метода на монтажа.
RO -Dimensiunile de mai sus sunt orientative, acestea pot varia în funcție de metoda de montare.

NON FOURNIS / NOT INCLUDED



FOURNIS SELON VOTRE MODÈLE / INCLUDED ACCORDING TO YOUR MODEL :

		A	B	C	D
A4 S04752	 Ø100 x 2300 mm	1	1	-	-
A7 S04755	 Ø100 x 2700 mm	-	-	1	1
B2 S04761	 Ø80 x 2300 mm	4	4	4	4
C1 S04843		2	2	2	2
101147 101148	  x1 50 kg max.	2	1	2	1
S04745	  x1 50 kg max.	-	-	1	1
S04746	  x1 50 kg max.	-	1	-	-
S04744	  x1 15 kg max.	-	-	-	1
4639	  x2 70 kg max. (2 x 35 kg)	1	1	1	1
D		4	4	5	5
E	 Ø6 mm	22	22	22	22
F	 Ø12 mm	4	4	5	5
G	 Ø12 mm	4	4	5	5
H	 Ø6 mm	22	22	22	22
I	 Ø12 mm	4	4	5	5
J		4	4	4	4
K	 Ø6 x 50 mm	22	22	22	22
SAV	S04854 BLISTER Portique Bois ronds	1	1	1	1
	S04855 BLISTER scellement	1	1	1	1
	S04856 BLISTER 2 crochets	2	2	1	1
	S04857 BLISTER 3 crochets	-	-	1	1

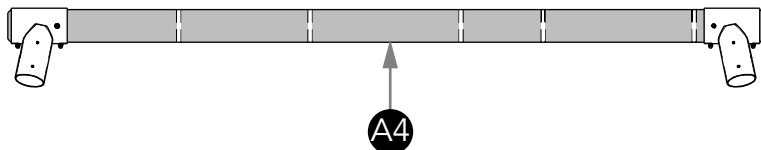
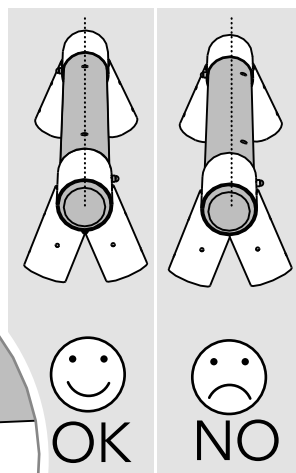
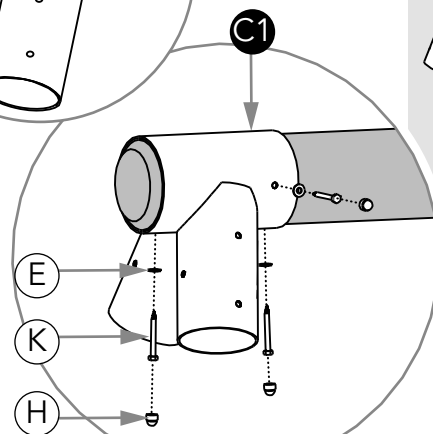
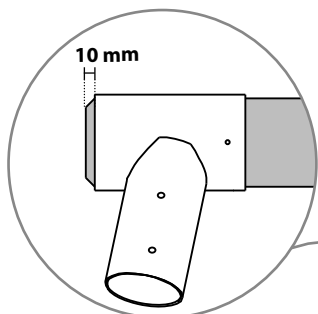
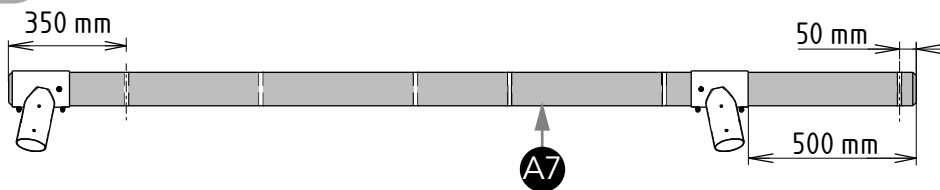
1**MONTAGE DES CONNECTEURS / ASSEMBLY OF CONNECTORS****SELON VOTRE MODÈLE /
ACCORDING TO YOUR MODEL :****A****B****A4** x1**C1** x2**E** x6**H** x6**K** x6**C****D****A7** x1**C1** x2**E** x6**H** x6**K** x6

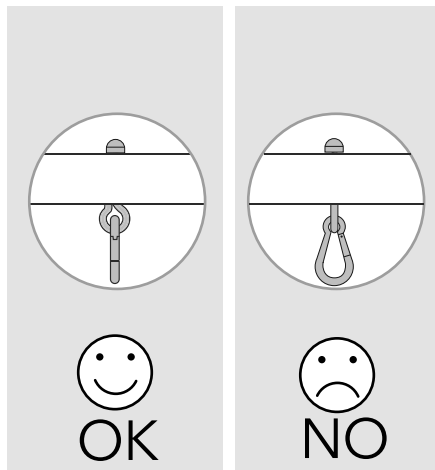
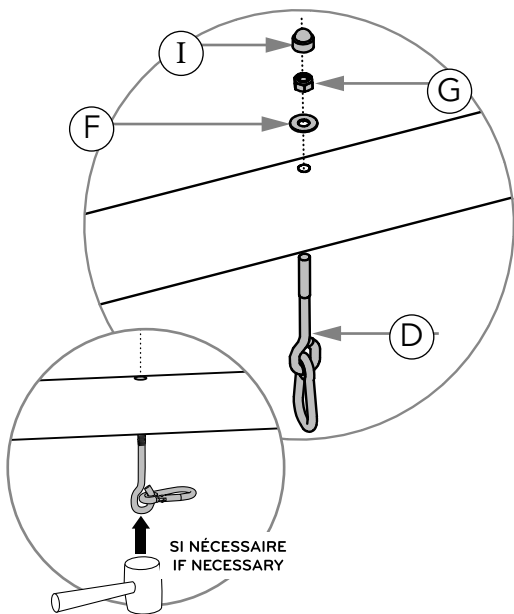

A B

- (D) x4
- (F) x4
- (G) x4
- (I) x4

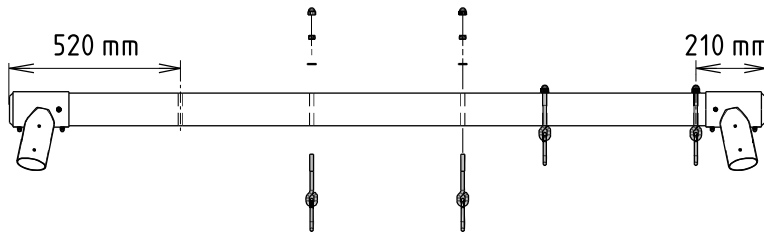

C D

- (D) x5
- (F) x5
- (G) x5
- (I) x5

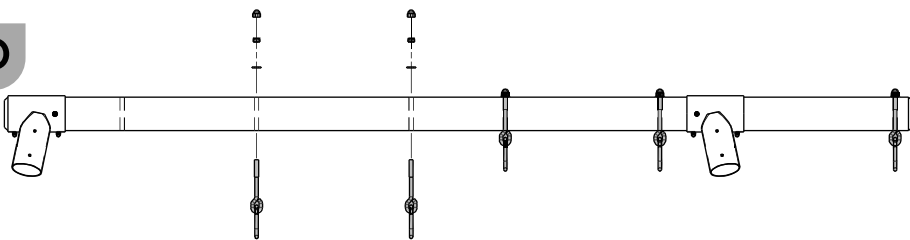

3 MONTAGE DES PIEDS / POSTS ASSEMBLY

3

A B C D

B2 x2

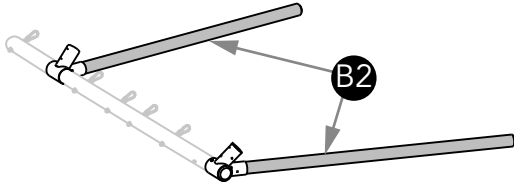
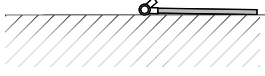

4

A B
C D

B2 x2

E x8

H x8

K x8

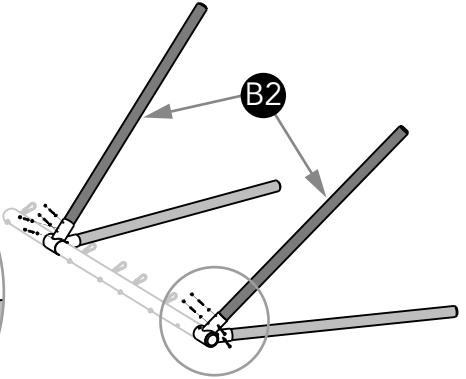
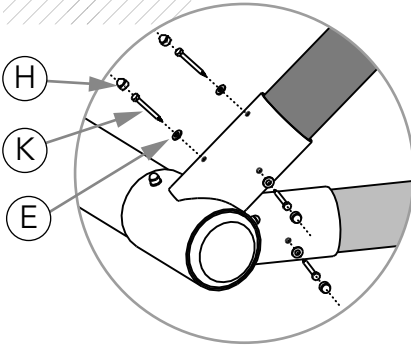
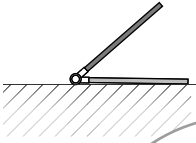

5

A B C D

E x4

H x4

K x4

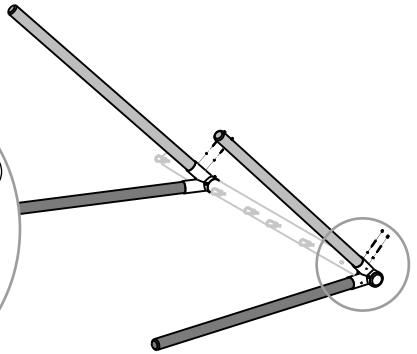
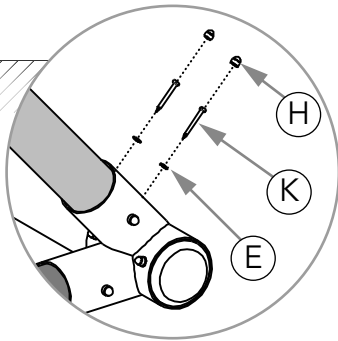
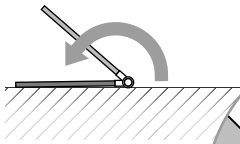

6

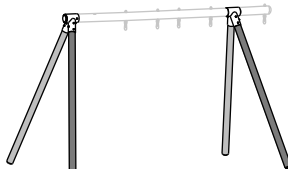
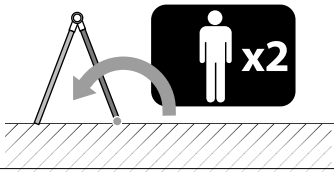

A

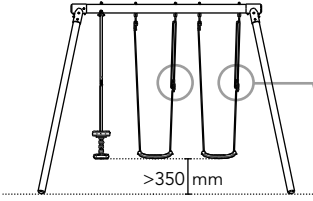

B

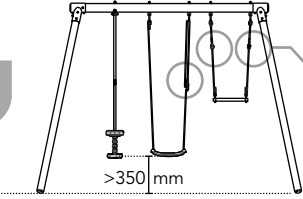

C

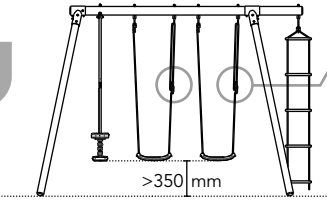

D

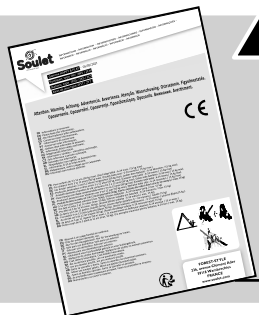
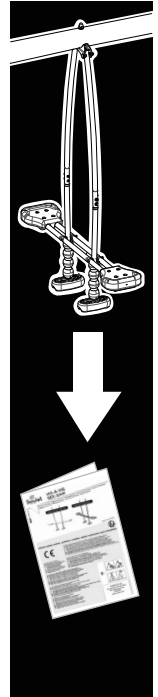
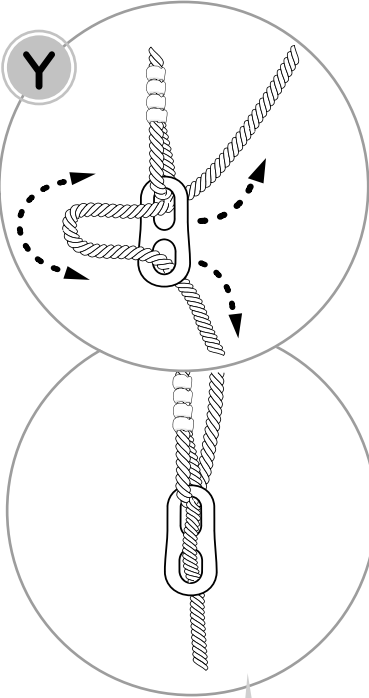
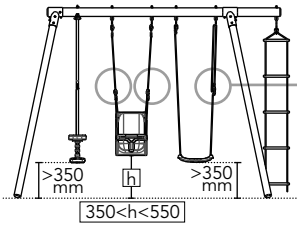

INFORMATIONS
 INFORMATION
 INFORMATIONEN
 INFORMACIONES
 INFORMAZIONI
 INFORMAÇÕES
 INFORMATIE
 INFORMAÇIE

INFORMĂCIÓ
 INFORMĂCIE
 INFORMACE
 INFORMASJE
 ΠΛΗΡΟΦΟΡΙΕΣ
 INFORMACIJE
 ИНФОРМАЦИЯ
 INFORMAȚII

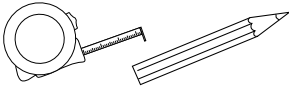

 = 35 x 35 cm

A

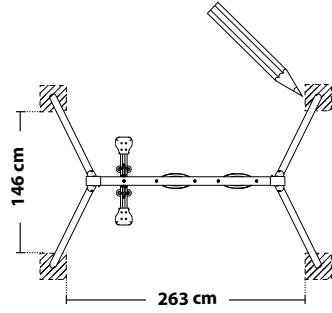
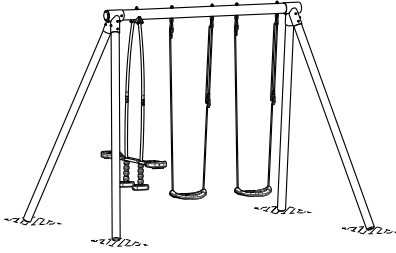

B

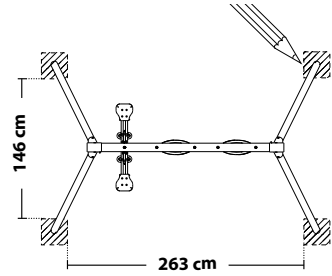
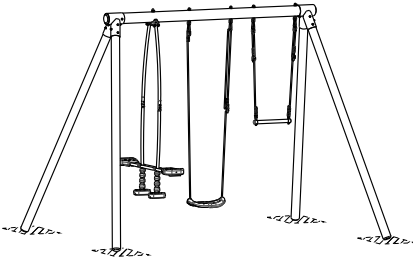

C

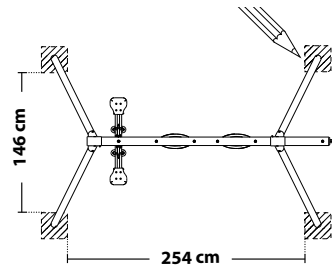
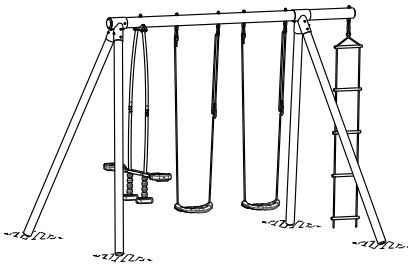

D

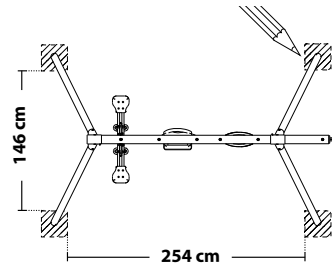
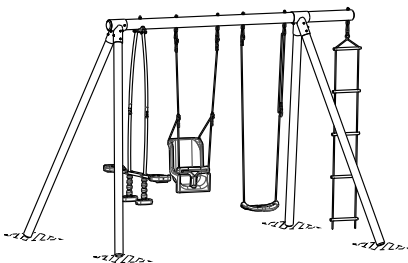

9

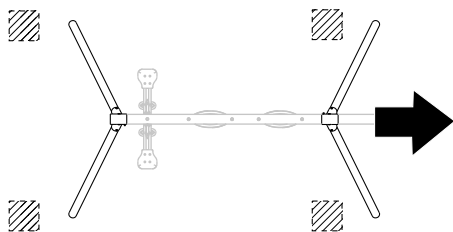

10

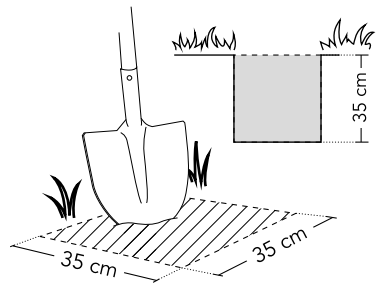

11

J x4

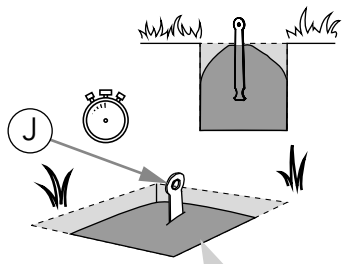

12

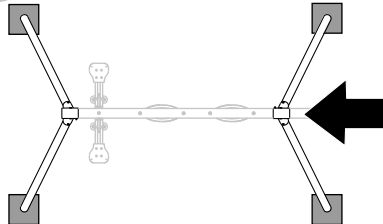

INFORMATIONS
 INFORMATION
 INFORMATIONEN
 INFORMACIONES
 INFORMAZIONI
 INFORMAÇÕES
 INFORMATIE
 INFORMACJE

INFORMÁCIÓ
 INFORMÁCIE
 INFORMACE
 INFORMACIJE
 ΠΛΗΡΟΦΟΡΙΕΣ
 INFORMAȚIJE
 ИНФОРМАЦИЯ
 ИНФОРМАЏИ

13

E x4
 H x4
 K x4

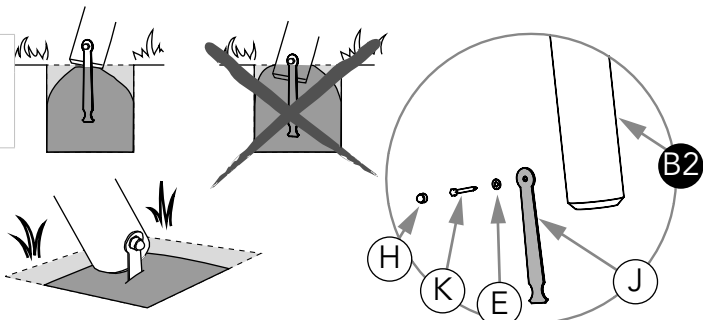

14

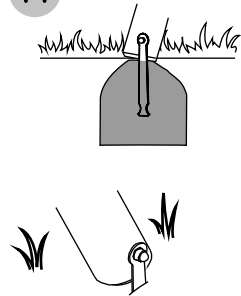



Soulet

FUN SINCE 1846

N° de lot / Batch N° :

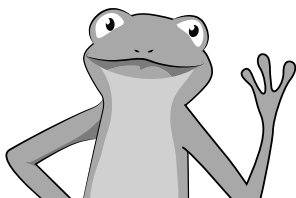

Bonjour !
Merci de m'avoir adopté !
C'est un plaisir de te rencontrer.



Je voudrais rester avec toi
de nombreuses années,
tu veux bien ?



Alors, s'il-te-plait,
prends quelques minutes de ton temps
pour activer ta garantie !

www.soulet.com

Rubrique déclaration de garantie